

CLAMP ON POWER HiTESTER 3169-20, 3169-21

Power Measuring Instruments



- Measure up to two 3-phase, 3-wire systems (displays voltage and current for three lines)
Measure up to four single-phase, 2-wire systems
- 0.5 A to 5000 A range



- Compact and light weight
- PC card data storage
- Power recording for individual waveforms
- Simultaneous recording of demand values and harmonics
- POWER MEASUREMENT SUPPORT SOFTWARE 9625



The photo shows the 3169-21 combined with CLAMP ON SENSORS 9661 and 9669 (optional) for measuring two systems.

The 3169-20/21 can also be used in combination with CLAMP ON SENSORS (optional) rated up to 5000 A.

Offering a new approach to energy-related measurement

such as energy conservation, ISO14001 testing, equipment diagnosis, and harmonics measurement.

Measures power lines of up to 254 mm in diameter

FLEXIBLE CLAMP ON SENSOR 9667

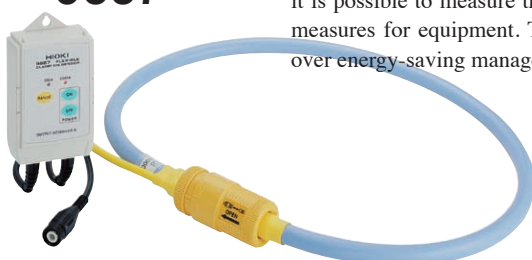

CLAMP ON POWER HiTESTERS are 3169-20 and 3169-21 that allow measurement of single-phase to three-phase 4-wire circuits with a single unit. In addition to measuring standard parameters such as voltage, current, power, power factor, and integrated values, these clamp-on power meters can simultaneously perform demand measurements required for carrying out power management and energy-saving measures, as well as harmonic measurements. The two new power meters also feature PC card data storage, and come equipped with an RS-232C interface for PC communications. Further, with greater data processing speeds, it is possible to measure the power of just a few cycles, enabling more detailed and effective energy-saving measures for equipment. The 3169-20 and 3169-21 are ideal for users who want to achieve close control over energy-saving management activities and measures.



ISO 9001
JMI-0216



ISO 14001
JQA-E-90091



www.hioki.com

Hioki company overview, new products, environmental considerations and other information are available on our website.

Offering a new measurement method for energy saving activities

All in a compact A5-size unit



Example of use in combination with four CLAMP ON SENSOR 9661 (optional)

Simultaneous measurement of two 3-phase, 3-wire systems.

Select the clamp-on sensor type most suited to your measurement needs for each individual circuit.



CLAMP ON SENSOR 9661 (500 A AC)
CLAMP ON SENSOR 9669 (1000 A AC)
(optional)

CLAMP ON POWER HiTESTER 3169-21
(Shown with D/A output)



Simultaneous recording of a variety of signal and energy-saving data.

Allows high-speed data transfer to a PC card for each waveform or at intervals of 0.1, 0.2, or 0.5 second.



VOLTAGE CORD L9438-53 (4 provided)



Features

■ Measure power lines of up to four systems (with a common voltage)

One single unit can measure four circuits (single-phase 2-wire), two circuits (3-phase, 3-wire), or a one circuit (3-phase, 4-wire) system.

■ A wide range of measurement functions

The 3169-20/21 can simultaneously measure voltage, current, power (active, reactive, and apparent), integrated power, power factor, and frequency. Further, when using 3-phase, 3-wire (3P3W2M) mode, you can display the voltage and current for all three lines by measuring just two of them. When using the 3-phase, 4-wire (3P4W4I) mode, neutral line current can be displayed using 4 current measurement.

■ Equipped with ranges from 0.5 A to 5000 A

The power meters support seven types of clamp-on current sensors to enable measurement for a variety of items, from CT terminals to large current and thick power lines.

■ Supports high-speed data storage from individual waveforms

When using the standard mode to perform integrated power measurement, you can store data in intervals starting from one second, and when simultaneously measuring integration and harmonics, in intervals starting from one minute. When in the fast mode, you can store RMS data for individual waveforms.

■ PC Card compatible plus internal hard drive for extra memory

Store valuable measurement data in convenient PC cards. The internal memory (1 MB) supports measurement over extended periods and detailed measurement parameters.

■ Housed in a compact A5 body size

The 3169-20 and 3169-21 feature a compact design that makes them portable and easy to use in tight spaces, and are approximately 30% more compact than the CLAMP ON POWER HiTESTER 3166.

■ Multi-language Compatibility

Select from nine languages, including Japanese and English.

■ Detect incorrect connection using vector diagrams

Use the vector display on the connection confirmation screen to check the phase, whether a connection is loose, or whether the clamp-on sensor connection has been reversed during VT/CT terminal measurement.

■ Polarity display and measurement using the reactive power measurement method

The units come equipped with a polarity display for checking LAG/LEAD when measuring power factor or reactive power. Further, you can select the reactive power measurement method, or display the phase factors for RMS values and power comparison.

■ High-speed D/A output

The 3169-21 comes equipped with 4-channel high-speed D/A output to enable analog output of RMS values for individual waveforms.

■ Ideal for power and harmonics management

The power meters come equipped with a harmonics measurement function that supports measurement of 3-phase power lines. They can also perform simultaneous measurement of harmonics and demand values, enabling both power and harmonics management.

The ultimate in clamp-on power meters!

Sleek Design and Engineering

The photo shows the 3169-21 with D/A output.

Voltage (VOLTAGE CORD L9438-53) input terminal
Current (CLAMP ON SENSOR) input terminal

D/A output terminal pin placement

Use the CONNECTION CABLE 9441 to connect to external devices. (Output resistance: 100 Ω)

Pin	Signal name
1	D/A output ch1
2	D/A output ch2
3	D/A output ch3
4	D/A output ch4
5 to 8	GND

Contrast adjust volume
Key lock switch
Power inlet
Power switch



External I/O terminal pin placement

Pin	Signal name	Pin	Signal name
1	Start/stop input	4	Data storage input
2	Free	5	GND
3	Status output		

Use the CONNECTION CABLE 9440 to connect to external devices.

Range Configuration Table

Voltage	Connection	CLAMP ON SENSOR 9695-02 (CAT III 300V) (500mA, 1A, 5A, 10A, 50A)			CLAMP ON SENSOR 9661 (5A, 10A, 50A, 100A, 500A)			
		CLAMP ON SENSOR 9694 (CAT III 300V) (500mA, 1A, 5A)			CLAMP ON SENSOR 9660, 9695-03 (CAT III 300V) (5A, 10A, 50A, 100A)			
		500.00mA	1.0000A	5.0000A	10.000A	50.000A	100.00A	500.00A
150.00V	Single-phase 2-wire	75.000 W	150.00 W	750.00 W	1.5000kW	7.5000kW	15.000kW	75.000kW
	Single-phase 3-wire	150.00 W	300.00 W	1.5000kW	3.0000kW	15.000kW	30.000kW	150.00kW
	Three-phase 3-wire	225.00 W	450.00 W	2.2500kW	4.5000kW	22.500kW	45.000kW	225.00kW
	Three-phase 4-wire	150.00 W	300.00 W	1.5000kW	3.0000kW	15.000kW	30.000kW	150.00kW
300.00V	Single-phase 2-wire	300.00 W	600.00 W	3.0000kW	6.0000kW	30.000kW	60.000kW	300.00kW
	Single-phase 3-wire	450.00 W	900.00 W	4.5000kW	9.0000kW	45.000kW	90.000kW	450.00kW
	Three-phase 3-wire	300.00 W	600.00 W	3.0000kW	6.0000kW	30.000kW	60.000kW	300.00kW
	Three-phase 4-wire	450.00 W	900.00 W	4.5000kW	9.0000kW	45.000kW	90.000kW	450.00kW
600.00V	Single-phase 2-wire	600.00 W	1.2000kW	6.0000kW	12.000kW	60.000kW	120.00kW	600.00kW
	Single-phase 3-wire	900.00 W	1.8000kW	9.0000kW	18.000kW	90.000kW	180.00kW	900.00kW
	Three-phase 3-wire	300.00 W	600.00 W	3.0000kW	6.0000kW	30.000kW	60.000kW	300.00kW
	Three-phase 4-wire	450.00 W	900.00 W	4.5000kW	9.0000kW	45.000kW	90.000kW	450.00kW

Voltage	Current Connection	CLAMP ON SENSOR 9669		
		100.00 A	200.00 A	1.0000kA
150.00V	Single-phase 2-wire	15.000kW	30.000kW	150.00kW
	Single-phase 3-wire	30.000kW	60.000kW	300.00kW
	Three-phase 3-wire	45.000kW	90.000kW	450.00kW
	Three-phase 4-wire	30.000kW	60.000kW	300.00kW
300.00V	Single-phase 2-wire	60.000kW	120.00kW	600.00kW
	Single-phase 3-wire	90.000kW	180.00kW	900.00kW
	Three-phase 3-wire	30.000kW	60.000kW	300.00kW
	Three-phase 4-wire	45.000kW	90.000kW	450.00kW
600.00V	Single-phase 2-wire	120.00kW	240.00kW	1.2000MW
	Single-phase 3-wire	180.00kW	360.00kW	1.8000MW
	Three-phase 3-wire	60.000kW	120.00kW	600.00kW
	Three-phase 4-wire	90.000kW	180.00kW	900.00kW

Voltage	Current Connection	FLEXIBLE CLAMP ON SENSOR 9667	
		500.00 A	5.0000kA
150.00V	Single-phase 2-wire	75.000kW	750.00kW
	Single-phase 3-wire	150.00kW	1.5000MW
	Three-phase 3-wire	225.00kW	2.2500MW
	Three-phase 4-wire	150.00kW	1.5000MW
300.00V	Single-phase 2-wire	300.00kW	3.0000MW
	Single-phase 3-wire	450.00kW	4.5000MW
	Three-phase 3-wire	150.00kW	1.5000MW
	Three-phase 4-wire	225.00kW	2.2500MW
600.00V	Single-phase 2-wire	600.00kW	6.0000MW
	Single-phase 3-wire	900.00kW	9.0000MW
	Three-phase 3-wire	300.00kW	3.0000MW
	Three-phase 4-wire	450.00kW	4.5000MW

Note 1: The range configuration table displays the full-scale display values for each measurement range. **Note 2:** In the table, "unit W" has been replaced with "VA" or "var" for the apparent power and reactive power measurement ranges. **Note 3:** Voltage and current input values 0.4% or less than the measurement range are displayed as "zero". When either the voltage or current for the power line is zero, the power value is displayed as zero. **Note 4:** You can display measurement values up to 130% of each measurement range.

Measure hidden power waste through secure connections, simple measurement methods, and detailed data capture.

Promises reliable measurement for power demand requirements!

Select from a variety of data, including detailed and harmonics data for multiple circuits

★ To measure multiple systems simultaneously

A single unit can measure two three-phase, 3-wire systems. Further, you can make individual clamp-on sensor and current range settings for each system.

Also, in addition to performing simultaneous measurement for up to four systems (single-phase, 2-wire) with a common voltage, you can set the current range individually for each system. Setting the most suitable current range for both large and small loads allows you to acquire more accurate measurements.

Measurement for up to four single-phase, 2-wire systems

Measurement for up to two three-phase, 3-wire systems

Use the 9661 sensor to measure a single system

Use the 9669 sensor to measure two systems

SCREEN WIRING CIRCUIT

★ When measurement accuracy is crucial

The addition of a vector display for viewing the connection status completes the preparation required for measurement.

Have you ever experienced incorrect measurement results? The most common cause of incorrect data is a faulty connection. With the 3169-20/21 you can use the vector display to check the phase, whether a connection is loose, or whether the clamp-on sensor connection has been reversed.

Also, you are assured of proper connection when measuring the VT (PT)/CT terminals even if you cannot see the line you are measuring.

Checking the connection on the vector display

Accurate and reliable results

The basic settings are constantly displayed, allowing you to measure with confidence.

During measurement, in addition to displaying the voltage and current ranges, and VT (PT) and CT ratios for each system, the unit can also display items such as the measurement interval. Because the basic settings are constantly visible, you can be confident of obtaining the correct measurement results.

★ Magnetic voltage adapters for hard-to-clip terminals

New magnetic voltage adapters convertible with the Voltage Cords L9438-53 let you accurately detect voltage when the circuit terminals are too shallow for alligator clips to latch on.

Options
Magnetic Adapter
9804-01, 9804-02

generally compatible with M6 pan screws

★ Capture facility data quickly

By using continuous processing to measure individual waveforms, you can accurately measure data in a relatively short amount of time.

Use the desired measurement method to continuously measure the voltage, current, and power for individual waveforms, enabling you to obtain accurate data in one second or less. Further, you can record the maximum, minimum and average values.

MAIN INST. CIRCUIT1

MAIN AVE. CIRCUIT1

MAIN MIN. CIRCUIT1

MAIN MAX. CIRCUIT1

U 300V x 1.00

I 10A x 1.00

WIRING 3P4W

CIRCUIT x1

PLL 50Hz

INTVL. 1min

SCREEN MINIMUM HOLD

★ Simultaneous power and harmonics management

Use a single unit to simultaneously measure data for power and harmonics.

All acquired data can be saved onto a PC card.

Power data (including demand data) and harmonics data can be simultaneously saved onto a PC card or in the unit's internal memory. Further, data for all of the systems being measured can be saved when measuring multiple circuits. Each of these two new unit's offers a management system for power and harmonic quality.

INTEG. CIRCUIT1

ACTIVE POWER WP+ 1.383311

CONSUMP. WP- -0.000001

REGEN. WP- -0.000001

REACTIVE POWER WQ+ 1.343161

WQ- -1.343161

START TIME 2002/05/18 0

STOP TIME 2002/05/19 0

ELAPSED TIME

SCREEN CIRCUIT

GRAPH CIRCUIT1

I1 LEVEL ORD 01 0.7009 A

U 150V x 1.00

I 5A x 1.00

WIRING 1P2W

CIRCUIT x1

PLL 60Hz

INTVL. 30min

SCREEN CH ITEM LIN/LOG HOLD

★ Measure another device simultaneously

Using the external I/O function, you can obtain even more detailed measurements for energy conservation.

In addition to measurement start/stop control through external input, you can use this function to output the measurement start/stop signal for the 3169-20/21. Simultaneous recording of a variety of signals is also possible for equipment when using multiple devices to perform start control and multi-channel recording.

Master control

Simultaneous operation

Synchronous with master

3169-20

3169-20

MEMORY RECORDER

Simultaneous control for signals from equipment

Large storage capacity to accommodate power and harmonics data for individual waveforms. -Supports energy saving measures that can be carried out from your PC.

Greater flexibility for energy saving measures through detailed measurement!

Reduce energy consumption by "1%"! Why not try analyzing your energy saving measures?

★ Save measurement details to PC card for extended measurements!

Why not try a shorter data management interval?

With the 3169-20/21, you can set the data recording interval to 1 minute. If you are unsure how to proceed with energy conservation, you can use a large capacity PC card to save measurement details, then use the data to create a load fluctuation graph and analyze this to help reduce wasted power consumption.

Further, because you can save a variety of data, including simultaneous recording of power and harmonics data, waveform data storage, and print-outs of the screen, these two new units help by storing measurement details.

Measurement conditions: 1-minute recording interval, when using a PC card (256 MB)

Data storage	1P2W x 4	1P3W x 2	3P3W2M x 2	3P3W3M, 3P4W
Normal measurement (only saves average, integrated, and demand values)	170 days	212 days	200 days	342 days
Normal measurement (saves all items)	90 days	82 days	74 days	124 days
Normal measurement + harmonics measurement (saves all items)	74 hours	80 hours	60 hours	92 hours

Interval	1P2W x 4	1P3W x 2	3P3W2M x 2	3P3W3M, 3P4W
1 minute	90 days (74 hours)	82 days (80 hours)	74 days (60 hours)	124 days (92 hours)
2 minutes	182 days (148 hours)	164 days (162 hours)	150 days (120 hours)	250 days (186 hours)
5 minutes	365 days (15 days)	365 days (16 days)	365 days (12 days)	365 days (19 days)
10 minutes	365 days (30 days)	365 days (32 days)	365 days (24 days)	365 days (38 days)
15 minutes	365 days (46 days)	365 days (50 days)	365 days (38 days)	365 days (58 days)
30 minutes	365 days (92 days)	365 days (100 days)	365 days (76 days)	365 days (116 days)

When using a 256 MB PC card

Measurement conditions: When saving all items using normal measurement, the number of days in parentheses indicate normal measurement + harmonics measurement, maximum measurement period of one year

★ Identify even small amounts of power waste using individual waveform measurements

The 3169-20/21 can help turn you into a keen energy saving specialist.

These two new units allow you to measure power data by recording the RMS values for individual waveforms.

By measuring just a few seconds of machine cycles or changes in operating patterns of facilities such as manufacturing equipment, you can grasp power fluctuations over a relatively short amount of time and view improvements in the form of numerical data. Gain unsurpassed energy savings by achieving simple improvements around the work environment.

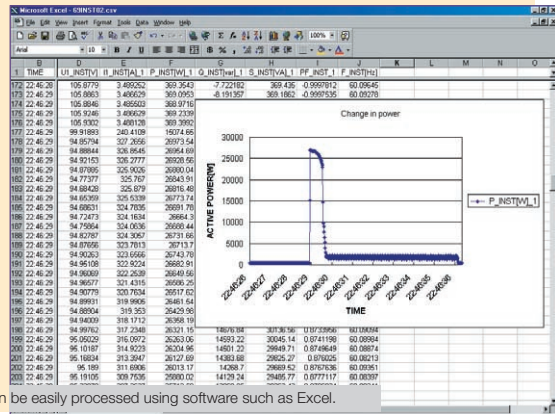

★ Improve energy-saving operations and create an energy-efficient facility

Why not try to improve your energy-saving measures using the 3169-21?

Using the D/A output (4 ch) function on the 3169-21, you can simultaneously record a variety of measurement and control signals for equipment, such as the power fluctuation and temperature/flow for individual waveforms, onto a HIOKI MEMORY HiRECORDER or logger.

A slight reduction in power consumption due to changes in the inverter motor operating patterns or temperature settings equals to an energy-saving effect.

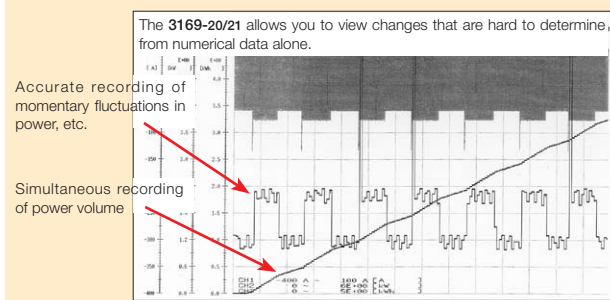

★ Unbalanced loads are an enemy to energy saving activities. Solve your problems with careful management of power lines.

Unbalanced 3-phase loads can result in a damaged power line.

To provide detailed management of measurements, the 3169-20/21 displays voltage and current for all three lines even when measuring just two circuits (3P3W2M). Further, because the effective power for each phase is displayed based on a virtual center point when measuring the voltage and current for all three lines (3P3W3M), the units can also be used to implement energy saving measures and power management systems.

When measuring 3P3W2M systems: Displays the voltage/current difference between each pair of lines and average values

When measuring with 3P3W3M systems: Displays the effective power for individual phases and the three-phase power values, as well as the voltage and current for all three lines

★ Harmonics cause wasted power

Did you think that harmonics and energy saving activities were unrelated?

Due to a spread in equipment that uses semiconductor control devices, such as inverters, power quality has decreased. Also, power consumed in harmonic components is all wasted power.

Harmonic control and management are essential for energy conservation.

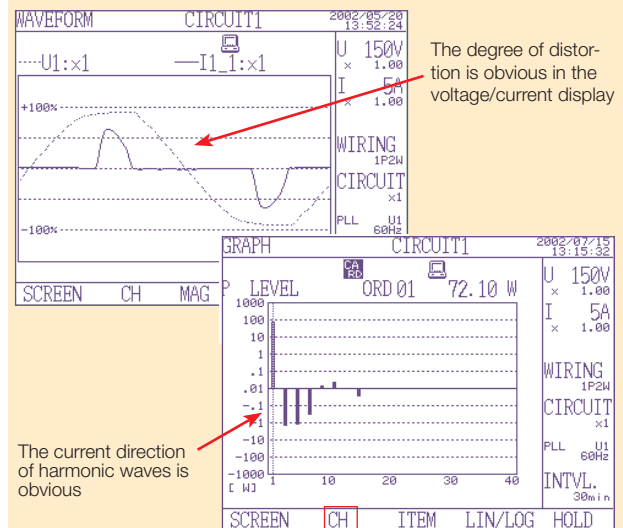

You can switch channels to easily check the harmonics for each circuit

★ To identify causal factors with harmonic measurements of multiple systems circuits

If production equipment malfunctions, power is wasted if repeated manufacture results in defective products again.

If you think harmonics are causing malfunctions, you can simultaneously measure the harmonics of individual circuits using multi-circuit measurement to obtain detailed information about the occurrence of harmonics along with the current direction for each phase. Using the 3169-20/21 you can accurately determine the relationship for harmonic inflow and outflow between power lines by analyzing the data acquired simultaneously, and then devising energy-saving measures based on the cause of the occurrence.

POWER MEASUREMENT SUPPORT SOFTWARE 9625

Graphically process measurement data from Model 3169-20/21 easily on a PC!

The POWER MEASUREMENT SUPPORT SOFTWARE 9625 application provides easy graphical processing on a computer of measurement data saved on CLAMP ON POWER HiTESTERS 3169-20/21 and 3166.

3169-20/21



3166



Power Data & Harmonic Data

Power Data & Harmonic Data

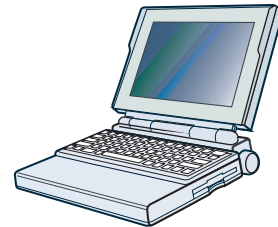

The 9625 handles both power and harmonic measurement data simultaneously.

Features

Time Series Graph Display Function

Measurement data can be displayed as a time series graph. Demand data measured in different series can be overlaid on the display.

Summary Display Function

Measurement data can be displayed directly in table form.

Daily, Weekly and Monthly Report Display Function

Daily, weekly and monthly reports of demand data can be displayed.

Harmonic Analysis Function

Display harmonic measurement data as a graph, list or waveform. (Also compatible with the harmonic measurement data captured by Model 3166.)

Print Function

Each screen can be printed.

Easily display and print various screens such as graphs and spreadsheet tables

Step 1. Load measurement data

Load up to 16 data sets from the 3169-20/21 or 3166 at once. Measured numerical values and waveform data are recognized and displayed automatically.

1. Loading and deleting data, and changing data names, can be done easily.
2. Multiple sets of measurement data can be loaded and managed in a single file.

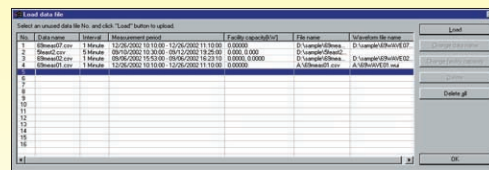

Step 2. Select the display (screen) type

Select from time series graph, summary, daily, weekly or monthly report, harmonic list, harmonic graph, harmonic waveform or settings.

Step 3. Select display items (two-axis display is possible)

1. Select the data items (up to 16) to display.
For graph displays, the type of graph (line or bar) can be selected.
2. Enter details for data display. (data item names, levels, etc.)

Step 4. Set the start/stop times and data interval to be displayed

1. Set the data period to display. (start/stop time and data interval)
 - The displayed period can be easily changed by scrolling.

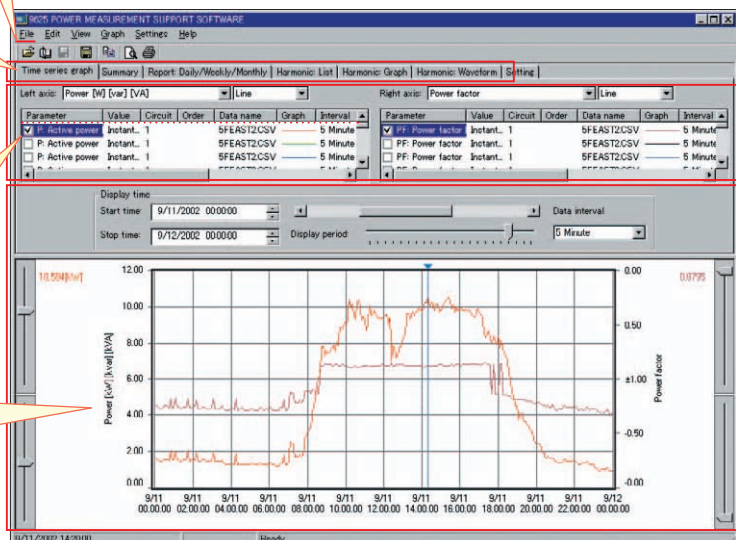

Time Series Graph Display Function (two-axes display possible)

The displayed graph can be set to suit particular start/stop times and data intervals. Harmonic time series graphs can be displayed.

Convenient Functions

- (1) The horizontal (time) axis can be easily scrolled to show the desired range.
- (2) Upper and lower limits (measurement values) of the vertical axis can be easily set and changed.
 - * Graph type (line, bar or stacked bar), line type (such as solid or dashed), color and details of upper and lower numerical values can be set.
- (3) Any desired numerical data value on a graph can be confirmed and displayed by cursor movement.
- (4) The display can be switched between 2D and 3D graphs.

Upper/Lower Limit Setting Slider

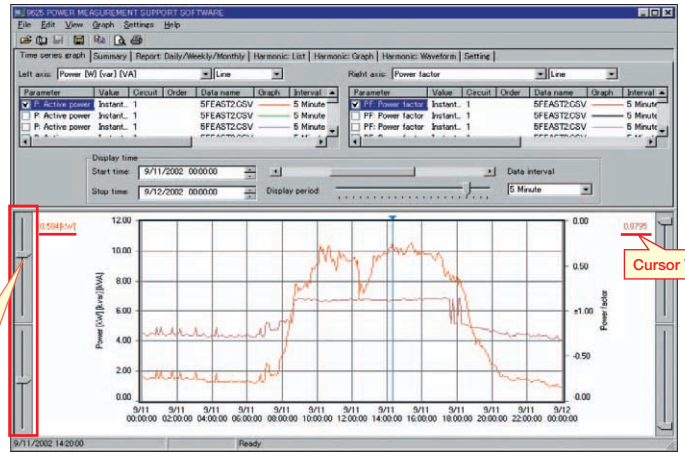

Summary Display Function

Summary

Displays a summary of the data values between specified start/stop times, at the specified data interval.

Convenient Functions

- (1) In addition to measurement values within the period being displayed, the summary shows period, maximum, minimum and average values.
- (2) Measurement data names and measurement units can be edited in the summary.

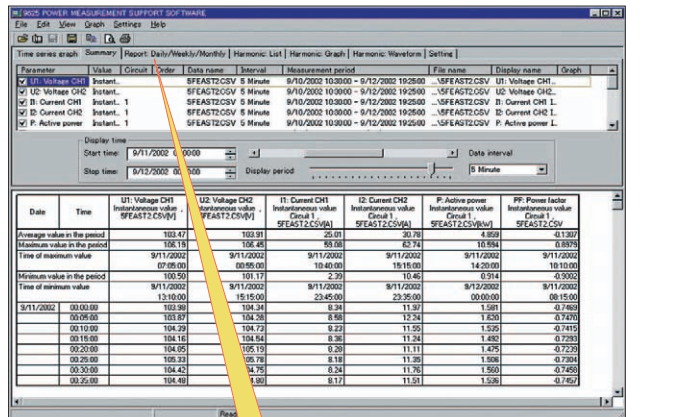

Daily, Weekly or Monthly Report Display

Displays a summary covering the total values in daily, weekly or monthly reports.

Convenient Functions

- (1) The time axis for each total scrolls to easily change the totalized period.
- (2) The total time range of measurement data can be totalized in up to four sections per time period.

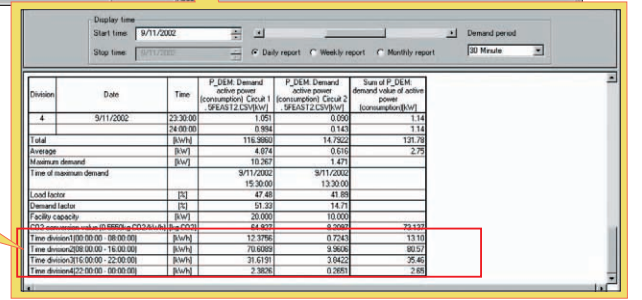
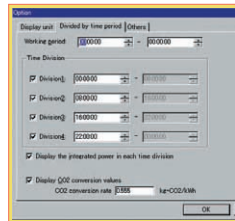

Harmonic Display Function Harmonic data measured by the 3169-20/21 and 3166 can be displayed in various ways

Harmonic Time Series Display

While displaying a time series graph, select the harmonic item for the vertical axis to display a time series graph of harmonics.

Convenient Functions

- (1) Up to 32 graphs can be displayed simultaneously using 2-axes display. For one circuit measurement, up to 32 orders can be graphed. Using multiple instruments, time series of harmonics can be easily compared.
- (2) Any desired chronological detail can be easily confirmed using the cursors on the graph.

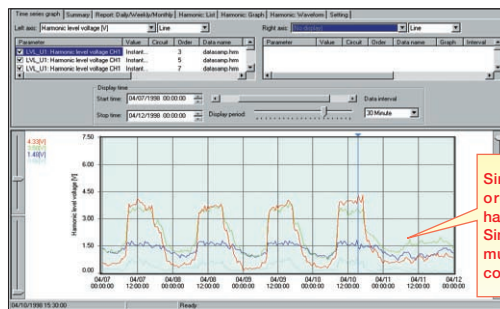

Simultaneously display multiple orders to confirm changes in harmonics!
Simultaneously display data from multiple instruments to confirm concurrent series of harmonics!

Harmonic List Display

Displays harmonic data for the selected display item as a list.

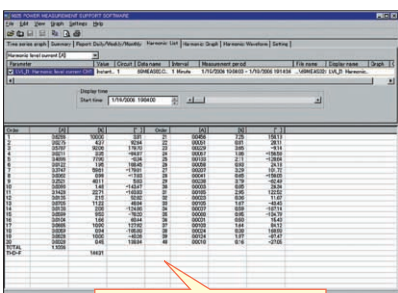

View the list to confirm details

Harmonic Graph Display

Displays harmonic data for the selected display item as a bar graph.

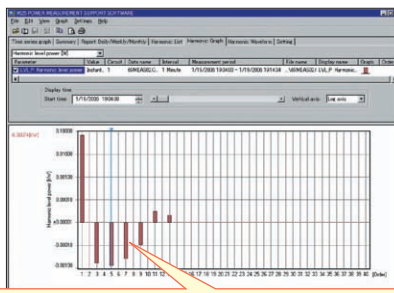

View the power graph to confirm trends in harmonics

Harmonic Waveform Display

Displays the voltage and current waveforms upon which harmonic data is based.

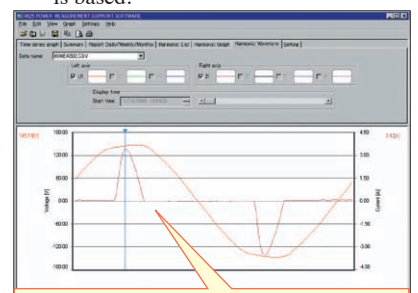

View the waveforms to confirm distortion conditions

Settings Display Function

When you select a data name to be load, the measuring instrument model and setting conditions at measurement time are displayed. Measurement data and measurement conditions can be managed at the same time.

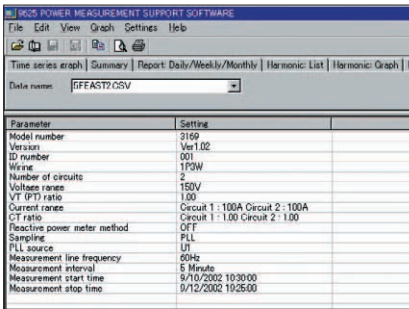

Print Function

Reports and screen copies of the displayed screen can be easily printed.

Convenient Functions

- (1) Printing results can be confirmed by print preview.
- (2) When creating a report, screen data can be copied and pasted into a commercial word processor program.

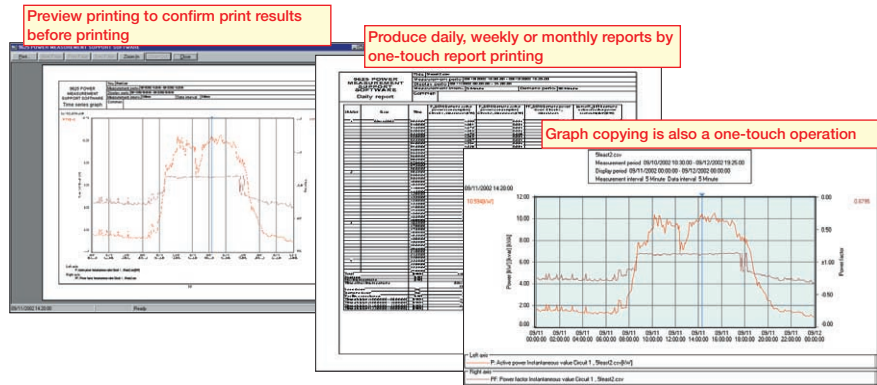

9625 Specifications

General Specifications

Supported instrument models : 3169-20, 3169-21 and 3166(CLAMP ON POWER HITESTERS)

Operating environment : Computer: PC-AT compatible (DOS/V machine)
 CPU: Pentium 200 MHz or higher
 Memory: 128 MB or more (recommended)
 Hard disk: 128 MB or more free space
 Display: XGA (1024×768) or higher
 Disc device: CD-ROM drive (for installation)
 Operating system: Windows 2000, XP, 7 (English edition)

Supplied Media : One CD-R disc

Functional Specifications

[Data/Setting Load/Save Functions]

	Loading data /Setting	File extension	Data format	Data contents
3169-20/21	Data file	CSV	CSV	Instantaneous value, average value, maximum value, minimum value, integrated value, demand value, harmonic
	Waveform data file	WUI	Binary	Instantaneous waveform
	Short-interval data file	BIN	Binary	Instantaneous values
3166	Integrated measurement data file	ITG	CSV	Instantaneous value, integrated value
	Demand measurement data file	DEM	CSV	Instantaneous value, maximum value, minimum value, demand value
	Harmonic measurement data file	HRM	CSV	Instantaneous value, average value, maximum value
	Waveform data file	WUI	Binary	Instantaneous waveform
	Setting file	SET	-	
9625	Combined file	DAT	Binary	

	Saved data /Setting	File extension	Data format
9625	Combined file	DAT	Binary

Maximum data capacity : Up to 528 MB per data set (total composite data up to 1.5 GB)

[Time Series Graph Display Function]

Graph display item : Voltage, current, active power, reactive power, apparent power, power factor, frequency, Integrated value(active power, reactive power), demand, harmonic (level, content ratio, phase angle, total value, THD)

Y-axis upper/lower limit setting : The display position (upper and lower display limits) of the vertical (Y) axis of a graph can be set by scroll bar or by specifying values.

Interval setting : Select each cycle, or 0.1, 0.2, 0.5, 1, 2, 5, 10, 15 or 30 sec.; 1, 2, 5, 10, 15 or 30 min.; or 1, 2, 3, 4, 6, 8 or 12 h; or 1 day

Display period range setting : An optional analysis period can be specified from the overall measurement data period

(1) Analysis start date and time (YMD, HMS) is specified numerically
 (2) Analysis stop date and time (YMD, HMS) is specified numerically

Display of measurement data period (measurement start and stop date and time)

Reference value setting : Display set standard value

Graph type selection : Line, bar, 2-axes and 3-dimensional

Graph line type & color setting : Line type and display color can be set for each data set, and marker display is possible

Stacked bar graph display : Up to 16 types of data series (demand value, demand quantity) can be displayed in an overlay graph

Cursor measurement : Measurement values can be displayed by the cursor

Data display units setting : Engineering units (m, k, M, G, etc.) can be selected

[Summary Display Function]	
Display item selection	: Select the items to display in the summary
Daily, weekly and monthly report display	: Displays a report for the specified daily weekly or monthly period
Load factor calculation display	: Calculates the load factor and demand factor as a daily, weekly or monthly report, and displays the results
Independent time range totalizing	: Specify up to four time ranges and totalize data for each time range independently
CO ₂ conversion display	: Display the integrated active power (kWh) in CO ₂ according to the conversion rate.
[Harmonic Display Function]	
Waveform display	: Displays waveform data for a specified time
List display	: Displays a list of harmonic data for a specified time
Graph display	: Display a bar graph of harmonic data for a specified time
Cursor measurement	: Displays the value at the cursor with waveform and graph displays
[Setting Display Function]	
Setting display	: Displays a list of the setting conditions Loads setting conditions from a data file (3169-20/21) Loads setting conditions from a settings file (3166)

[Copy Function]	
Copies to the clipboard	: Each display can be copied to the clipboard
[Print Function]	
Printing a displayed time series graph	: Previews and prints the contents displayed on a time series graph
Printing a displayed summary	: Previews and prints the contents displayed in a summary
Printing a harmonic display	: Previews and prints the contents displayed in a harmonic spreadsheet
Printing the settings display	: Previews and prints the contents displayed in the settings display
Comment entry	: Text comments can be entered in any printout
Printing support	: Any color or monochrome printing supported by the operating system
[Display Language]	
Language	: English
[CSV Format Conversion Function]	
Convertible screens	: Time-series graph; Summary; Daily, Weekly and Monthly Report; Harmonic Waveform

■ 3169-20/21 Specifications

■ Basic Specifications

Measurement line type	: Single-phase 2-wire, single-phase 3-wire, three-phase 3-wire, and three-phase 4-wire systems (50/60 Hz)
Number of systems that can be measured (for systems that share the same voltage)	: Single-phase: 1P2W 4 systems 1P3W 2 systems Three-phase: 3P3W2M (measures the voltage and current for two lines) 2 systems 3P3W3M (measures the voltage and current for all three lines) 1 system 3P4W (measures the voltage and current for three lines) 1 system 3P4W4I (measures the voltage for three lines and the current for four lines)
Item	: Voltage, current, active power, reactive power, apparent power, power factor, integrated value, frequency, harmonics
Measurement range	: For the voltage, current, and active power ranges, see the range configuration tables on page 2.
Measurement method	: Simultaneous digital sampling of voltage and current, PLL synchronization or a fixed clock (50/60 Hz)
Input methods	: Voltage: Isolated input Current: Isolated input using a clamp-on sensor
Effective measurement area	: Within 5 to 110% of the range
Total display area	: Voltage and current: Within 0.4 to 130% of the range (zero is suppressed for less than 0.4%) Power: Within 0 to 130% of the range (zero is suppressed when the voltage or current is zero) Harmonic level: Within 0 to 130% of the range
Display	: 5.7-inch LCD (320 × 240 dots), with backlight
Range switching method	: Manual (the current range can be set for each system)
Display update rate	: Approx. every 0.5 seconds (except when using a PC card while accessing the internal memory, or when performing RS-232C communications)
Input resistance (50/60 Hz)	: Voltage: 2.0 MΩ ± 10% (differential input) Current: 200 kΩ ± 10%
Maximum input	: Voltage input: 780 Vrms AC, peak value: 1103 V Current input: 1.7 Vrms AC, peak value: 2.4 V
Maximum rated voltage to earth	: Voltage input terminals: 600 Vrms AC (50/60 Hz)
Crest factor	: Voltage: Less than 2 (for full-scale input) Current: Less than 4 (for full-scale input. However, less than 2 for the 500 A, 1 kA, and 5 kA ranges)
Internal memory capacity	: 1MB

■ Display Specifications

Instantaneous value display	: Voltage, current, active power, reactive power, apparent power, power factor, frequency, average voltage, average current, (average values are for each system)
Average value display	: Voltage, current, active power, reactive power, apparent power, power factor, frequency, average voltage, average current * The average value from the beginning of time series measurement until the present.
Maximum/minimum value display	: Voltage, current, active power, reactive power, apparent power, power factor, frequency * The maximum/minimum value from the beginning of time series measurement until the present.
Integrate display	: Integrated value Active power (consumption/regeneration) Reactive power (lag/lead) * The total integrated value from the beginning of time series measurement.
Demand volume display (Integrated value within the specified interval)	: Integrated value Active power volume (consumption/regeneration) Reactive power volume (lag/lead) * The integrated value within each specified interval (latest value).
Demand value display (average value within the specified interval)	: Active power (consumption), reactive power (lag), power factor * The demand value within each specified interval (previous value).
Maximum demand value display (average value within the maximum specified interval)	: The maximum demand value since the beginning of time series measurement and the time and date it occurred.
Harmonics list	: List of the items measured for the specified harmonic (numerical value). (including the total value and total harmonic distortion factor (THD-F/THD-R))
Harmonics graph	: Bar graph or vector diagram of the items measured for the specified harmonic. (cursor measurement, magnification update, with a linear/LOG axis selection function)
Waveform display	: Voltage and current waveforms (with a magnification update function)
Measurement value enlargement display	: Select and enlarge up to 5 items from the instantaneous value display.

■ Measurement Specifications

[Voltage/current measurement]	
Measurement method	: True RMS method
Measurement display	: Measurement of three voltage lines and 3 or 4 current lines is possible when using three-phase 3-wire and three-phase 4-wire systems
[Active power measurement]	
Measurement display	: For three-phase 3-wire (the 3P3W3M setting), refer to the display for phase power values.
Polarity display	: For consumption: no symbol, for regeneration: "-"
[Reactive power measurement]	
Using the reactive power measurement method	: ON: Measures the reactive power directly using the reactive power measurement method OFF: Calculates the reactive power from the measurement values for voltage, current, and active power
Polarity display	: For lag phase (LAG: current is slower than voltage): no symbol For lead phase (LEAD: current is faster than voltage): "-" (Reactive power measurement method "ON")
[Apparent power measurement]	
Polarity display	: No polarity
[Power factor measurement]	
Measurement range	: -1.0000 (lead) to 0.0000 to +1.0000 (lag)
Polarity display	: For lag phase (LAG: current is slower than voltage): no symbol For lead phase (LEAD: current is faster than voltage): "-"
[Frequency measurement]	
Measurement range	: 40.000 to 70.000 Hz
Input area for guaranteed accuracy	: Within 10 to 110% of the range (for sine wave input)
Measurement source	: Voltage U1

[Frequency measurement]	
Measurement range	: 40.000 to 70.000 Hz
Input area for guaranteed accuracy	: Within 10 to 110% of the range (for sine wave input)
Measurement source	: Voltage U1
[Integrated measurement]	
Measurement range	: Active power : 0.00000 mWh to 99999.9 GWh consumption -0.00000 mWh to -99999.9 GWh regeneration Reactive power : 0.00000 mvarh to 99999.9 Gvarh lag -0.00000 mvarh to -99999.9 Gvarh lead
Measurement display	: Active power : Displays consumption and regeneration separately Reactive power : Displays lag and lead separately
[Harmonic measurement]	
Measurement range	: Basic wave frequency: 45 to 66 Hz
Measurement method	: PLL synchronization
Order for analysis	: Up to the 40th order
Window width	: A single cycle (number of data points analyzed: 128 points)
Window type	: Rectangular
Analysis rate	: 1/16 cycles
Item for analysis	: Harmonic level: The voltage, current, or power level for each harmonic order Harmonic content percentage: The voltage, current, or power content percentage for each harmonic order Harmonic phase angle: The voltage, current, or power phase angle for each harmonic order Total value: The total value for voltage, current, or power up to the 40th harmonic order Total harmonic distortion factor: For voltage or current (THD-F or THD-R)

Setting Specifications

[Setting contents]	
Measurement line settings	1P2W, 1P3W, 3P3W2M, 3P3W3M, 3P4W, 3P4W4I
Clamp-on sensor settings	9694, 9660, 9661, 9667, 9669, 9695-02 and 9695-03 (* A different sensor can be set for each system.)
VT (PT) and CT ratio settings	0.01 to 9999.99 (* A different CT ratio can be set for each system.)
Measurement start method	Manual or time (year, month, day, hour, minute)
Measurement stop method	Manual, time, or timer (1 seconds to 8784 hours)
Output Interval	Standard or fast (*Maximum measurement period: 1 year) Standard interval: 1, 2, 5, 10, 15, or 30 seconds, or 1, 2, 5, 10, 15, 30, or 60 minutes Fast interval: A single waveform, or 0.1, 0.2, or 0.5 seconds
Data output destination	PC card, internal memory, or printer
File name	Automatically attached, or set the desired name (up to 8 alphanumeric characters)
Display averaging circuit	OFF, 2, 5, 10, 20 times (for movement averaging)
Screen copy destination	PC card, internal memory, or printer
Display language settings	Japanese, English, German, French, Italian, Chinese (Simple, Trad), Spanish, Korean
Other settings	Reactive power measurement method selection, harmonic distortion selection, order display selection, backlight settings, ID settings, clock settings, etc.
[File operations]	
Copy file	Copies files from the internal memory to the PC card.
Load/Save selected file	Loads/Saves the file(s) selected from the internal memory or PC card.
Delete file	Deletes the file(s) from the PC card.
Format	Initializes the PC card or internal memory.
Storage format	Measurement data: CSV format (binary format when using the fast interval setting) Waveform data: Binary format Screen data: BMP format Settings data: CSV format

External Interface Specifications

[D/A output] (3169-21 only)	
Number of output channels	4 channels
Output items	For instantaneous values: Voltage, current, average voltage, average current, Active power, reactive power, apparent power, power factor, frequency For Integrated value: Active power (consumption/regeneration) or reactive power (lag/lead) For harmonics: Each harmonic order (level, content percentage, and phase angle), total value, THD-F/THD-R
Output level	±5V DC/f.s.
Resolution	Polarity + 11 bits
Output accuracy	Measurement accuracy ±0.2% f.s.
Temperature characteristic	Less than ±0.02% f.s./°C
Output resistance	100Ω ±5%
Output update rate	For each cycle of measurement input (when a measurement item other than harmonics is set) For every 16 cycles of measurement input (when harmonics is set as the measurement item)
[PC card]	
Slot	1 × PC Card Standard-compliant Type II
Card type	Flash ATA card
Compatible memory capacity	Up to 528 MB
Storage content	Settings data, measurement data, screen data
[RS-232C]	
	Printer or PC connected to an RS-232C interface
Compliance	EIA RS-232C-compliant
Transfer method	Asynchronous communication method, full duplex
Baud rate	2400, 9600, 19200, 38400 bps
Flow control and delimiter settings	possible
[External I/O]	
Control input	Start/stop control for time series measurement, data storage
Control output	LOW level is output during time series measurement.
Control signal level	A 0/5 V logic signal or a short-circuit/release contact signal

General Specifications

Operating environment	Indoors, up to 2000m (78.74ft) ASL
Operating temperature and humidity	0 to 40°C, 80% RH or less (non-condensating)
Storage temperature and humidity	-10 to 50°C, 80% RH or less (non-condensating)
Withstand voltage (50/60 Hz for 15 sec.)	5.55 kVrms AC: Between the voltage input terminal and the 3169 casing 3.32 kVrms AC: Between the voltage input terminal and the current input terminal/external interface terminal 2.3 kVrms AC: Between the power supply and the 3169 casing 1.39 kVrms AC: Between the power supply and the current input terminal/external interface terminal
Power supply voltage rating	100 to 240 V AC, 50/60 Hz
Maximum rated power	30 VA
Dimensions and weight	Approx. 210(8.27") W × 160(6.30") H × 60D(2.36") mm (excluding protrusions), Approx. 1.2 kg(42.3oz.) (3169-20, 3169-21)

[Data output item]	
Instantaneous values	Voltage, current, active power, reactive power, apparent power, power factor, frequency, average voltage, average current, (average values are for each system) * The instantaneous value for interval output.
Average value	Voltage, current, active power, reactive power, apparent power, power factor, frequency, average voltage, average current, (average values are for each system) * The average value for each interval.
Maximum/minimum value	Voltage, current, active power, reactive power, apparent power, power factor, frequency * The maximum/minimum value for each interval (no event details provided).
Integrated value	Active power (consumption/regeneration) Reactive power (lag/lead) * The total value since the beginning of time series measurement, and the power volume for each interval.
Demand value	Active power (consumption), reactive power (lag), power factor * The value for each interval.
Maximum demand value	The maximum demand value since the beginning of time series measurement and the time and date it occurred.
Harmonic	Each harmonic order (level, content percentage, and phase angle), total value, instantaneous value for THD-F/THD-R Each harmonic order (level, content percentage, and phase angle), total value, average value for THD-F/THD-R for each interval Each harmonic order (level, content percentage, and phase angle), total value, maximum/minimum value for THD-F/THD-R within each interval (no event data provided)
Waveform	Waveform (Voltage or current)
Status information	Exceeds the voltage/current crest factor, PLL unlock, power failure, exceeds the display limit
[Print items]	
Numerical values	Prints the data selected as the data output item (during time series measurement).
Waveform	Hard copy of the screen (printing of each interval not available)

Formulae

(for single-phase 2-wire systems)

$$\text{Voltage } U = \sqrt{\frac{1}{M} \sum_{s=0}^{M-1} (U_s)^2}$$

$$\text{Current } I = \sqrt{\frac{1}{M} \sum_{s=0}^{M-1} (I_s)^2}$$

$$\text{Active Power } P = \frac{1}{M} \sum_{s=0}^{M-1} (U_s \times I_s)$$

U : Inter-line voltage

I : Line current

M : Number of samples

s : Sample count

m : 128 samples per cycle

Measurement is also possible using the reactive power measurement method

In addition to conventional calculation methods that search for reactive power using voltage, current, and active power, you can select the reactive power measurement method, which derives reactive power directly from voltage and current values, just as with the reactive power volume measurement method used in large-volume power consumers.

When using the reactive power measurement method:

$$\text{Reactive power } Q = \frac{1}{M} \sum_{s=0}^{M-1} \left\{ U_s \times I \left(s + \frac{m}{4} \right) \right\}$$

$$\text{Apparent power } S = \sqrt{P^2 + Q^2}$$

$$\text{Power factor } PF = \frac{P}{\sqrt{P^2 + Q^2}}$$

Derives reactive power directly from voltage and current values, just as with the measurement of active power.

(The same measurement principle is the same as that used to determine reactive power by large-volume power consumers.)

When not using the reactive power measurement method:

$$\text{Reactive power } Q = \sqrt{S^2 - P^2}$$

$$\text{Apparent power } S = U \times I$$

$$\text{Power factor } PF = \frac{P}{S}$$

Calculates reactive power after calculating the apparent power using the voltage, current, and RMS values.

Conforming standards	Safety EN61010 Pollution degree 2, measurement category III (anticipated transient overvoltage 6000V)
	EMC EN61326 EN61000-3-2, EN61000-3-3

Accessories	voltage cord set L9438-53 (1) (1 cord each of black, red, yellow, and blue), voltage cord (1), input cord label (1), operating manuals (2) (Advanced edition and Quick Start Guide), CD-R (1) (RS-232C interface operating manuals and CSV conversion Software), connection cable 9441 (1) (for the 3169-21 only)
-------------	---

Measurement accuracy (Guaranteed accuracy period : 1 year)

Voltage	Current/active power
±0.2%rdg.±0.1%f.s.	±0.2% rdg. ±0.1% f.s. + clamp-on sensor accuracy

Conditions of guaranteed accuracy	: After 30 minutes of warm-up, sine-wave input, PF=1
Temperature and humidity for guaranteed accuracy	: 23°C ±5°C, less than 80% relative humidity
Fundamental waveform range for guaranteed accuracy	: 45 to 66 Hz
Display area for guaranteed accuracy	: Effective measurement area

Table of current and active power accuracy with clamp-on sensor combinations

Current range	9694	9695-02	9660, 9695-03	9661	9669	9667
0.5A	±0.5%rdg±0.3%f.s.	±0.5%rdg±2.1%f.s	-	-	-	-
1A	±0.5%rdg±0.2%f.s.	±0.5%rdg±1.1%f.s	-	-	-	-
5A	±0.5%rdg±0.12%f.s.	±0.5%rdg±0.3%f.s	±0.5%rdg±0.5%f.s.	±0.5%rdg±1.1%f.s.	-	-
10A	-	±0.5%rdg±0.2%f.s	±0.5%rdg±0.3%f.s.	±0.5%rdg±0.6%f.s.	-	-
50A	-	±0.5%rdg±0.12%f.s.	±0.5%rdg±0.14%f.s.	±0.5%rdg±0.2%f.s.	-	-
100A	-	-	±0.5%rdg±0.12%f.s.	±0.5%rdg±0.15%f.s.	±1.2%rdg±0.2%f.s.	-
200A	-	-	-	-	±1.2%rdg±0.15%f.s.	-
500A	-	-	-	±0.5%rdg±0.11%f.s.	-	±2.2%rdg±0.4%f.s.
1000A	-	-	-	-	±1.2%rdg±0.11%f.s.	-
5000A	-	-	-	-	-	±2.2%rdg±0.4%f.s.

Reference: Accuracy of the CLAMP ON SENSORE 9694,9695-02, 9695-03, 9660, 9661, 9667, and 9669

- 9694 (rated for 5 A) : ±0.3%rdg±0.02%f.s.
- 9695-02 (rated for 50 A) : ±0.3%rdg±0.02%f.s.
- 9695-03 (rated for 100 A) : ±0.3%rdg±0.02%f.s.
- 9660 (rated for 100 A) : ±0.3%rdg±0.02%f.s.
- 9661 (rated for 500 A) : ±0.3%rdg±0.01%f.s.
- 9669 (rated for 1000 A) : ±1.0%rdg±0.01%f.s.
- 9667 (rated for 5000 A) : ±2.0%rdg±1.5mV
(500 A range: For 50 to 500 A input)
(5000 A range: For 500 to 5000 A input)





* f.s. is the sensor's rated primary current value.



Note: The table of accuracy for different clamp-on sensor combinations indicates the measurement accuracy for each current range of the 3169-20/21. (The accuracy for each clamp-on sensor is converted and displayed according to the 3169-20/21 current measurement range.)

- Apparent power accuracy** : ±1 dgt. for the calculation obtained from each measurement value
- Reactive power accuracy** : When using the reactive power measurement method
±0.2% rdg. ±0.1% f.s. + clamp-on sensor accuracy
When not using the reactive power measurement method
±1 dgt. for the calculation obtained from each measurement value
- Integration accuracy** : ±1 dgt. for the measurement accuracy of effective power, reactive power, and apparent power
- Power factor accuracy** : ±1 dgt. for the calculation obtained from each measurement value
- Frequency accuracy** : ±0.5% rdg. ±1dgt.

- Frequency characteristic** : Fundamental waveforms up to the 50th order ±3% f.s. + measurement accuracy (of a 45- to 66-Hz fundamental waveform)
- Temperature characteristic** : Within ±0.03% f.s./°C
- Effect of in-phase voltage** : Within ±0.2% f.s.
(600 Vrms AC, 50/60 Hz, between voltage input terminal and case)
- Effect of external magnetic field** : Within ±1.5% f.s.
(in a magnetic field of 400 A/m rms AC, 50/60 Hz)
- Power factor influence** : ±1.0% rdg.
(45 to 66 Hz, power factor = 0.5, for effective power measurement)
- Effect of reactive factor** : ±1.0% rdg.
(45 to 66 Hz, reactive factor = 0.5, when using the reactive power measurement method)
- Real-time clock accuracy** : ±10 ppm ±1 second (23°C) (within ±1.9 sec/day (23°C))

Option Specifications

CLAMP ON SENSOR	9694	9660	9661	9669
Appearance	 Cord length: 3 m (9.84ft) CAT III 300V	 Cord length: 3 m (9.84ft) CAT III 300V	 Cord length: 3 m (9.84ft) CAT III 600V	 Cord length: 3 m (9.84ft) CAT III 600V
Primary current rating	AC 5 A	AC 100 A	AC 500 A	AC 1000 A
Output voltage	AC 10mV/A	AC 1mV/A	AC 1mV/A	AC 0.5mV/A
Accuracy	±0.3%rdg±0.02%f.s. Within ±2°	±0.3%rdg±0.02%f.s. Within ±1°	±0.3%rdg±0.01%f.s. Within ±0.5°	±1.0%rdg±0.01%f.s. Within ±1°
Frequency characteristic	Within ±1.0% at 40 Hz to 5 kHz (deviation from accuracy)			Within ±2.0% at 40 Hz to 5 kHz (deviation from accuracy)
Effect of external magnetic field	Equivalent to 0.1 A or less (with a magnetic field of 400 A/m AC)			Equivalent to 1 A or less (with a magnetic field of 400 A/m AC)
Effect of conductor position	Within ±0.5%			Within ±1.5%
Maximum rated voltage to earth	300 V rms (insulated conductor)	300 V rms (insulated conductor)	600 V rms (insulated conductor)	600 V rms (insulated conductor)
Maximum input (45 to 66 Hz)	50 A continuous	130 A continuous	550 A continuous	1000 A continuous
Measurable conductor diameter	Less than φ 15 mm(0.59")	Less than φ 15 mm(0.59")	Less than φ 46 mm(1.81")	Less than φ 55 mm(2.17"), 80(3.15") × 20 (0.79")mm bus bar
Dimensions and weight	46W(1.81") × 135H(5.31") × 21D(0.83") mm, 230g(9.9oz.)	46W(1.80") × 135H(5.31") × 21D(0.83") mm, 230g(9.9oz.)	77W(3.03") × 151H(5.94") × 42D(1.65")mm, 380g(12.7oz.)	99.5W(3.92") × 188H(7.40") × 42D(1.65") mm, 590g(20.8oz.)

CLAMP ON SENSOR	9667	9695-02	9695-03
Appearance	 Cord length: Sensor - circuit: 2 m(6.56ft) Circuit - connector: 1 m(3.28ft) CAT III 1000V	 CAT III 300V	 CAT III 300V
Primary current rating	AC 500 A, 5000A	AC 50 A	AC 100 A
Output voltage	AC 500 mV f.s.	AC 10 mV/A	AC 1 mV/A
Accuracy	±2.0%rdg±1.5mV (for input 10% or more of the range) Within ±1°	±0.3%rdg±0.02%f.s. Within ±2°	
Frequency characteristic	Within ±3 dB at 10 Hz to 20 kHz (deviation from accuracy)	Within ±1.0% at 40 Hz to 5 kHz (deviation from accuracy)	
Effect of external magnetic field	Equivalent to 5 A, 7.5 A max. (with a magnetic field of 400 A/m AC)	Equivalent to 0.1 A or less (with a magnetic field of 400 A/m AC)	
Effect of conductor position	Within ±3.0%	Within ±0.5%	
Maximum rated voltage to earth	1000 V rms (insulated conductor)	300 V rms (insulated conductor)	
Maximum input (45 to 66 Hz)	10000 A continuous	60 A continuous	130 A continuous
Measurable conductor diameter	Less than φ 254 mm(10.0")	Less than φ 15 mm(0.59")	
Dimensions and weight	Sensor: 910 mm(2.99ft) long, 240g(8.5oz.), Circuit: 57W(2.24") × 86H(3.39") × 30D(1.18") mm, 140g(4.9oz.)	50.5W(1.99") × 58H(2.28") × 18.7D(0.74")mm, 50g(1.8oz.)	
Power supply	LR03 alkaline battery × 4 (continuous operation max. 168 hours) or AC ADAPTER 9445-02/9445-03(optional)	Option : CONNECTION CABLE 9219	

Option Specifications

PRINTER 9442



Print method : Thermal serial dot printing
 Paper width : 112 mm(4.41ft)
 Print speed : 52.5cps
 Power supply : AC adapter 9443-02, or supplied nickel-metal hydride battery (approx. 3000 lines of printing when fully charged and used with the 9443-02)
 Dimensions and weight : Approx. 160W (6.30") x 66.5H(2.62") x 17D(0.67") mm, approx. 580g(20.5oz.)

When purchasing the printer 9442, make sure you also purchase the RS-232C cable 9721 and AC adapter 9443-02 so that you can connect it to the 3169-20/21.

RS-232C CABLE 9721



Cord length for connecting to the 9442: 1.5 m(4.92ft)

AC ADAPTER 9443-02



For the 9442

CONNECTION CABLE 9440



For external I/O

Cord length: 2m(2.65ft)

CONNECTION CABLE 9441



For D/A output (supplied with the 3169-21)

Cord length: 2 m(2.65ft)

CLAMP ON POWER HiTESTER 3169-20

(supplied with the voltage cord L9438-53 (1), and power cord (1))

CLAMP ON POWER HiTESTER

3169-21 (with D/A output)

(supplied with the voltage cord L9438-53 (1), connection cable 9441 (1) and power cord (1))

Accessory Specifications

VOLTAGE CORD L9438-53 (1 cord each of black, red, yellow, and blue, cord length: 3 m(9.84ft))

CONNECTION CABLE 9441 (D/A output cable, supplied with the 3169-21)

Current and power cannot be measured using the CLAMP ON POWER HiTESTER 3169-20/21 on its own. To perform current and power measurement, make sure you also purchase a CLAMP ON SENSOR (9694, 9660, 9661, 9667, or 9669) (sold separately).

Use only PC Cards (9727, 9728) sold by HIOKI.

Compatibility and performance are not guaranteed for PC cards made by other manufacturers. You may be unable to read from or save data to such cards.

● Combination examples

For single-phase 2-wire systems (one system) : 3169-20 + 9660(100A) x 1 + 9727(256MB)

For single-phase 3-wire systems (one system/two single-phase 2-wire systems) : 3169-20 + 9660(100A) x 2 + 9727(256MB)

For three-phase 3-wire systems (one system) : 3169-20 + 9661(500A) x 2 + 9727(256MB)

For three-phase 3-wire systems (two systems/four single-phase 2-wire systems) : 3169-20 + 9661(500A) x 4 + 9727(256MB)

For three-phase 4-wire systems (one system) : 3169-20 + 9661(500A) x 3 + 9727(256MB)

PC CARD 9727, 9728



Use only PC Cards (9727, 9728) sold by HIOKI.

Models 9729 1G PC Card and 9780 2G PC Card are not compatible with this device.

MAGNETIC ADAPTER 9804-01, 02



Magnetic tip for use with the standard Voltage Cord L9438-53 (generally compatible with M6 pan screws)

Red and black adapters sold separately. Purchase the quantity and color appropriate for your application. (Example: 3P3W - 3 adapters; 3P4W - 4 adapters)

CLAMP ON ADAPTER 9290-10



Cord length: 3 m(9.84ft)

Max. 1500 A AC (continuous: 1000 A)
 Measurable conductor diameter:
 Bus bar : ϕ 55 mm(2.17"), width 80 mm(3.14")
 CT ratio: 10:1
 *Used for expanding the measurement ranges of the 9660 and 9661 sensors

CONNECTION CABLE 9219



For connection to the 9695-02, 9695-03

Cord length: 3 m(9.84ft)

CARRYING CASE 9720-01

A soft type case for storing the 3169-20/21 and its accessories, such as the clamp-on sensors.

Dimensions : Approx. 445W(17.52") x 340H(13.39") x 150D(5.91") mm, approx. 2.2 kg(77.6oz.)



Options

CLAMP ON SENSOR 9660 (AC 100A)

CLAMP ON SENSOR 9661 (AC 500A)

FLEXIBLE CLAMP ON SENSOR 9667 (AC 5000A)

CLAMP ON SENSOR 9669 (AC 1000A)

CLAMP ON SENSOR 9694 (AC 5A)

CLAMP ON SENSOR 9695-02 (AC 50A)

CLAMP ON SENSOR 9695-03 (AC 100A)

CONNECTION CABLE 9219 (for connection to the 9695-02, 9695-03)

CLAMP ON ADAPTER 9290-10 (AC 1500A)

CONNECTION CABLE 9440 (for external I/O)

RS-232C CABLE 9612 (for connection to a PC)

PRINTER 9442

AC ADAPTER 9443-02 (for the 9442, for Europe)

RS-232C CABLE 9721 (for connection to the 9442)

RECORDING PAPER 1196 (25 m(82ft)/10 rolls, for the 9442)

CARRYING CASE 9720

POWER MEASUREMENT SUPPORT SOFTWARE 9625

PC CARD 256M 9727

PC CARD 512M 9728

MAGNETIC ADAPTER (1 red adapter) 9804-01

MAGNETIC ADAPTER (1 black adapter) 9804-02

Note: Company names and Product names appearing in this catalog are trademarks or registered trademarks of various companies.

HIOKI

HIOKI E. E. CORPORATION

Headquarters :

81 Koizumi, Ueda, Nagano, 386-1192, Japan
 TEL +81-268-28-0562 / FAX +81-268-28-0568
 http://www.hioki.co.jp / E-mail: os-com@hioki.co.jp

HIOKI USA CORPORATION :

6 Corporate Drive, Cranbury, NJ 08512 USA
 TEL +1-609-409-9109 / FAX +1-609-409-9108
 http://www.hiokiusa.com / E-mail: hioki@hiokiusa.com

HIOKI (Shanghai) Sales & Trading Co., Ltd. :

1608-1610, Shanghai Times Square Office, 93 Huai Hai Zhong Road
 Shanghai, P.R.China POSTCODE: 200021
 TEL +86-21-63910090/63910092 FAX +86-21-63910360
 http://www.hioki.cn / E-mail: info@hioki.com.cn

Beijing Office : TEL +86-10-84418761 / 84418762

Guangzhou Office : TEL +86-20-38392673 / 38392676

HIOKI INDIA PRIVATE LIMITED :

Khandela House, 24 Gulmohar Colony Indore 452 018 (M.P.), India
 TEL +91-731-4223901, 4223902 FAX +91-731-4223903
 http://www.hioki.in / E-mail: info@hioki.in

HIOKI SINGAPORE PTE. LTD. :

33 Ubi Avenue 3, #03-02 Vertex, Singapore 408868
 TEL +65-6634-7677 FAX +65-6634-7477
 E-mail: info@hioki.com.sg

DISTRIBUTED BY